

NPN TRANSISTOR POWER MODULE

- HIGH CURRENT POWER BIPOLAR MODULE
- VERY LOW R_{th} JUNCTION CASE
- SPECIFIED ACCIDENTAL OVERLOAD AREAS
- ISOLATED CASE (2500V RMS)
- EASY TO MOUNT
- LOW INTERNAL PARASITIC INDUCTANCE

INDUSTRIAL APPLICATIONS:

- MOTOR CONTROL
- SMPS & UPS
- WELDING EQUIPMENT

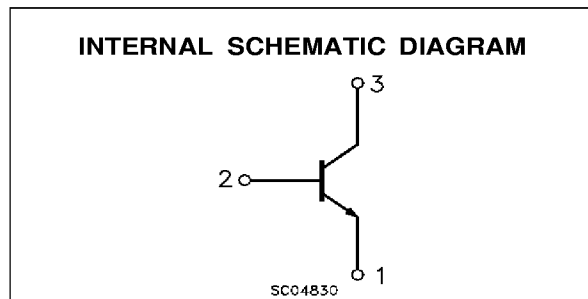
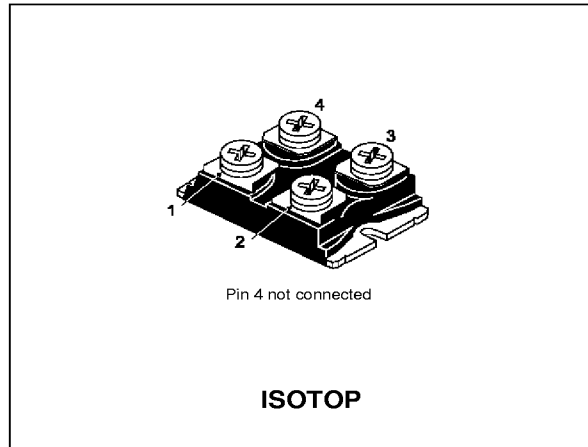

ABSOLUTE MAXIMUM RATINGS

Symbol	Parameter	Value	Unit
V_{CEV}	Collector-Emitter Voltage ($V_{BE} = -5\text{ V}$)	1000	V
$V_{CEO(sus)}$	Collector-Emitter Voltage ($I_B = 0$)	450	V
V_{EBO}	Emitter-Base Voltage ($I_C = 0$)	7	V
I_C	Collector Current	30	A
I_{CM}	Collector Peak Current ($t_p = 10\text{ ms}$)	60	A
I_B	Base Current	8	A
I_{BM}	Base Peak Current ($t_p = 10\text{ ms}$)	16	A
P_{tot}	Total Dissipation at $T_c = 25\text{ °C}$	150	W
T_{stg}	Storage Temperature	-55 to 150	°C
T_j	Max. Operating Junction Temperature	150	°C
V_{ISO}	Insulation Withstand Voltage (AC-RMS)	2500	°C

BUV98AV

THERMAL DATA

$R_{thj-case}$	Thermal Resistance Junction-case	Max	0.83	°C/W
R_{thc-h}	Thermal Resistance Case-heatsink With Conductive Grease Applied	Max	0.05	°C/W

ELECTRICAL CHARACTERISTICS ($T_{case} = 25\text{ °C}$ unless otherwise specified)

Symbol	Parameter	Test Conditions	Min.	Typ.	Max.	Unit
I_{CER}	Collector Cut-off Current ($R_{BE} = 5\ \Omega$)	$V_{CE} = V_{CEV}$ $V_{CE} = V_{CEV}$ $T_j = 100\text{ °C}$			1 8	mA mA
I_{CEV}	Collector Cut-off Current ($V_{BE} = -5V$)	$V_{CE} = V_{CEV}$ $V_{CE} = V_{CEV}$ $T_j = 100\text{ °C}$			0.4 4	mA mA
I_{EBO}	Emitter Cut-off Current ($I_C = 0$)	$V_{EB} = 5\ V$			2	mA
$V_{CEO(SUS)}^*$	Collector-Emitter Sustaining Voltage	$I_C = 0.2\ A$ $L = 25\ mH$ $V_{clamp} = 450\ V$	450			V
h_{FE}^*	DC Current Gain	$I_C = 24\ A$ $V_{CE} = 5\ V$		9		
$V_{CE(sat)}^*$	Collector-Emitter Saturation Voltage	$I_C = 16\ A$ $I_B = 3.2\ A$ $I_C = 24\ A$ $I_B = 5\ A$			1.5 5	V V
$V_{BE(sat)}^*$	Base-Emitter Saturation Voltage	$I_C = 16\ A$ $I_B = 3.2\ A$			1.6	V
di_C/dt	Rate of Rise of On-state Collector	$V_{CC} = 300\ V$ $R_C = 0$ $t_p = 3\ \mu s$ $I_{B1} = 6\ A$ $T_j = 100\text{ °C}$	100			A/ μs
$V_{CE(3\ \mu s)}$	Collector-Emitter Dynamic Voltage	$V_{CC} = 300\ V$ $R_C = 15\ \Omega$ $I_{B1} = 6\ A$ $T_j = 100\text{ °C}$			8	V
$V_{CE(5\ \mu s)}$	Collector-Emitter Dynamic Voltage	$V_{CC} = 300\ V$ $R_C = 15\ \Omega$ $I_{B1} = 6\ A$ $T_j = 100\text{ °C}$			4	V
t_s t_f	Storage Time Fall Time	$I_C = 16\ A$ $V_{CC} = 50\ V$ $V_{BB} = -5\ V$ $L_B = 1.5\ \mu H$ $V_{clamp} = 300\ V$ $I_{B1} = 3.2\ A$ $L = 750\ \mu H$ $T_j = 100\text{ °C}$			5 0.4	μs μs
V_{CEW}	Maximum Collector Emitter Voltage Without Snubber	$I_{Cwoff} = 30\ A$ $I_{B1} = 6\ A$ $V_{BB} = -5\ V$ $V_{CC} = 50\ V$ $L = 750\ \mu H$ $L_B = 15\ \mu H$ $T_j = 125\text{ °C}$	350			V

* Pulsed: Pulse duration = 300 μs , duty cycle 1.5 %

Safe Operating Areas

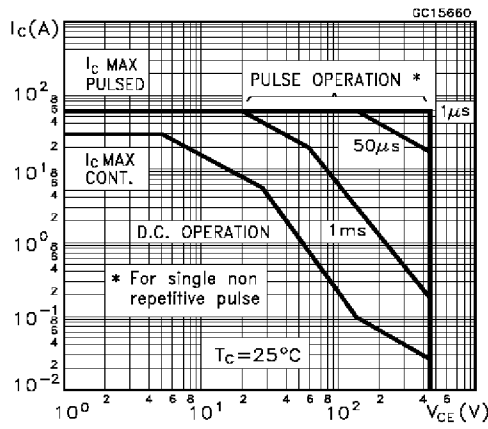

Thermal Impedance

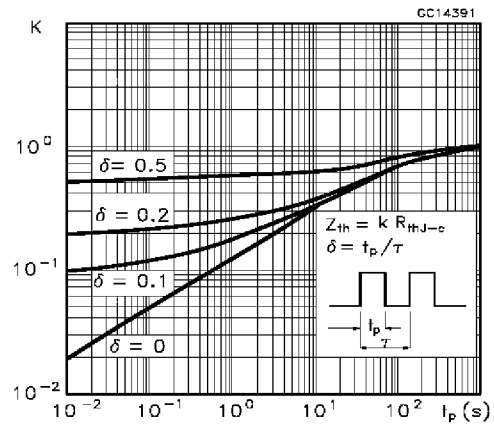

Derating Curve

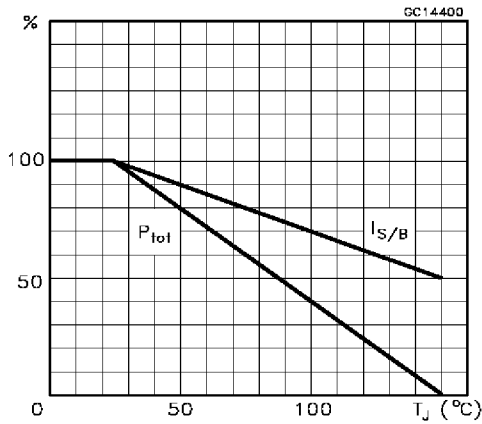

Collector-emitter Voltage Versus base-emitter Resistance

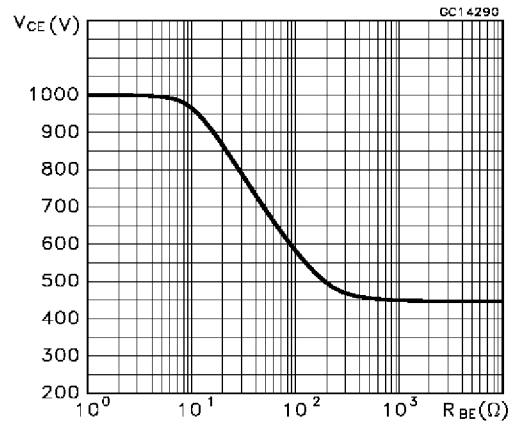

Collector Emitter Saturation Voltage

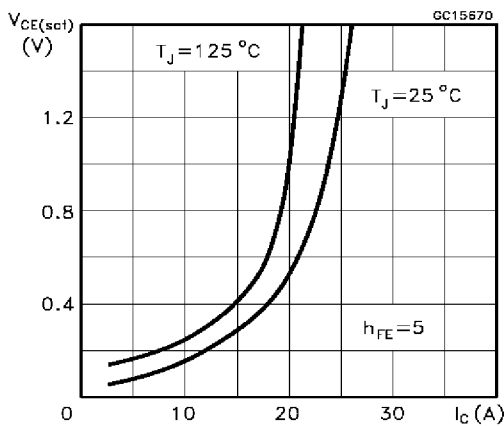

Base-Emitter Saturation Voltage

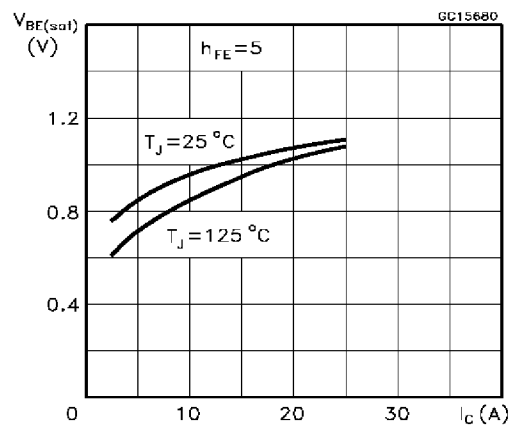

Reverse Biased SOA

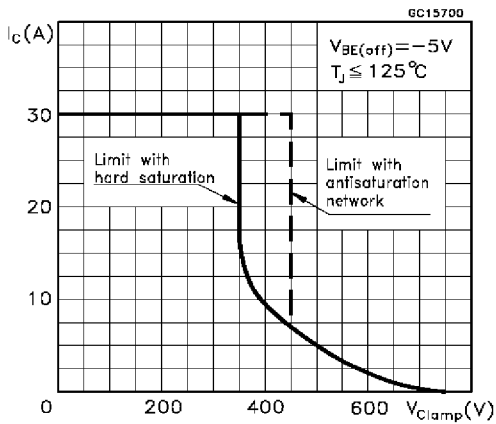

Forward Biased SOA

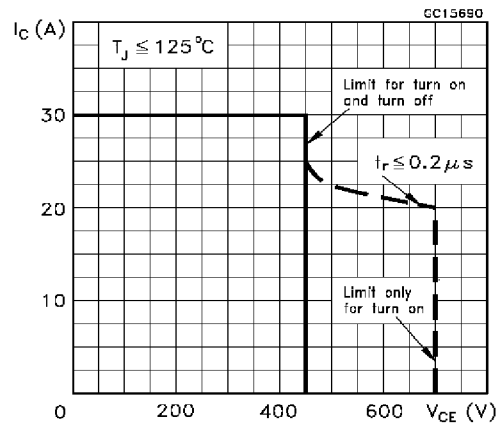

Reverse Biased AOA

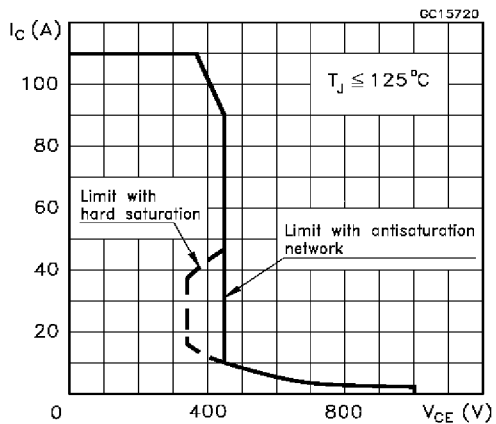

Forward Biased AOA

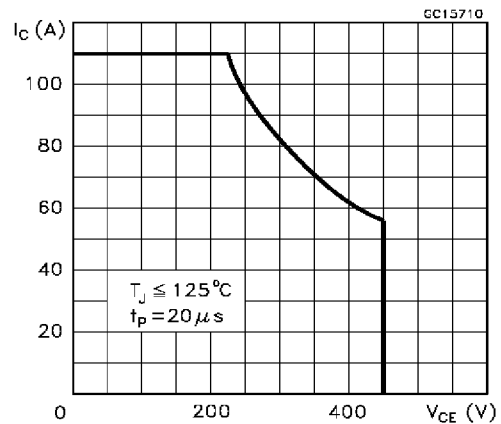

Switching Times Inductive Load

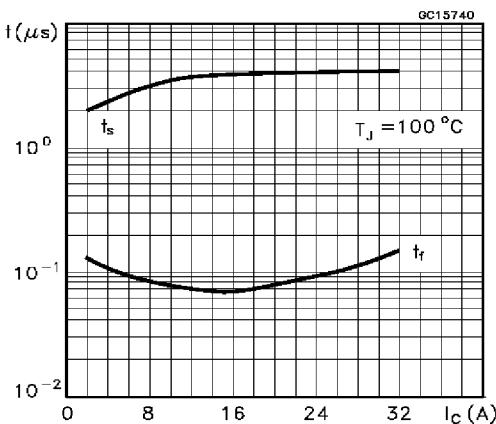

Switching Times Inductive Load Versus Temperature

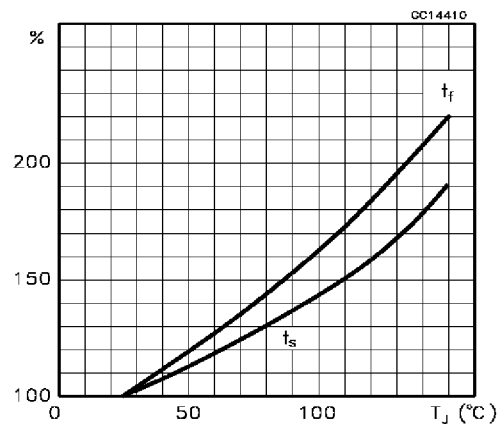

Dc Current Gain

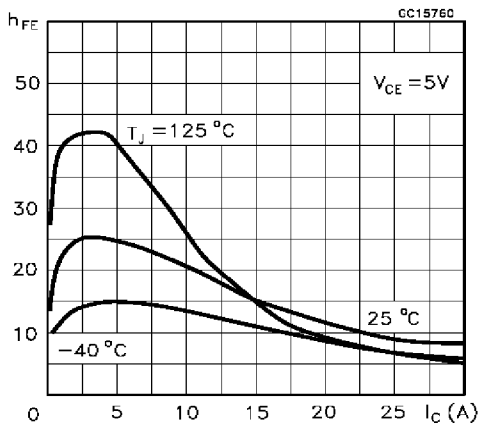

Turn-on Switching Test Circuit

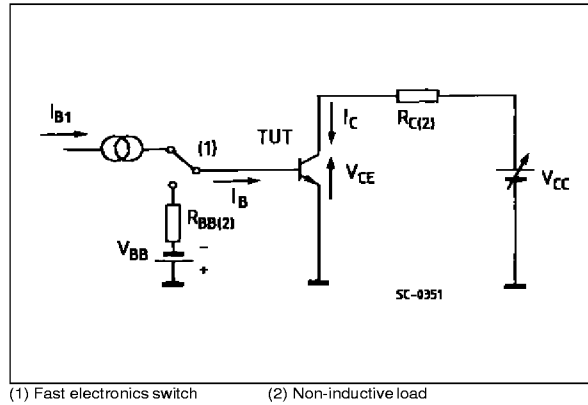

(1) Fast electronics switch (2) Non-inductive load

Turn-on Switching Waveforms

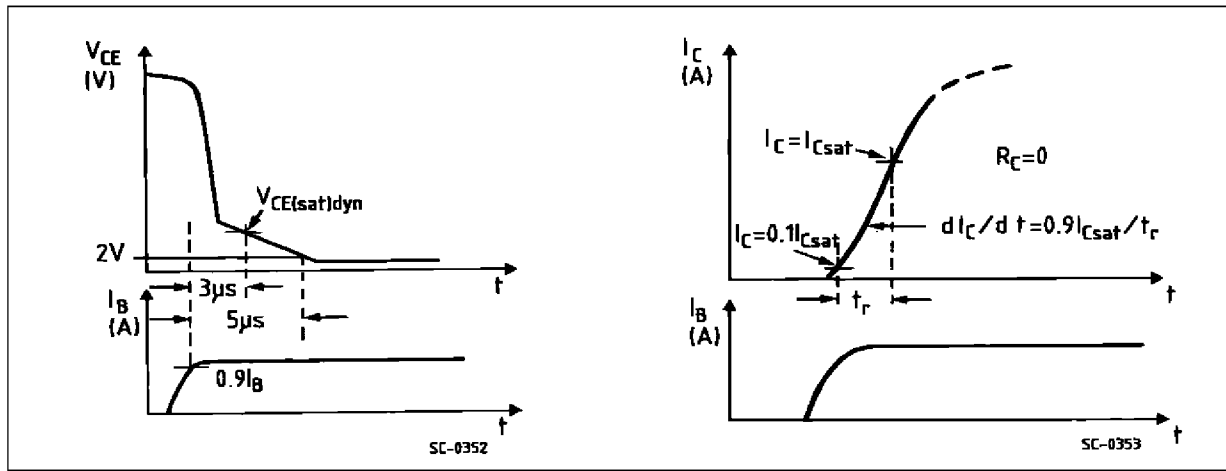

Turn-off Switching Test Circuit

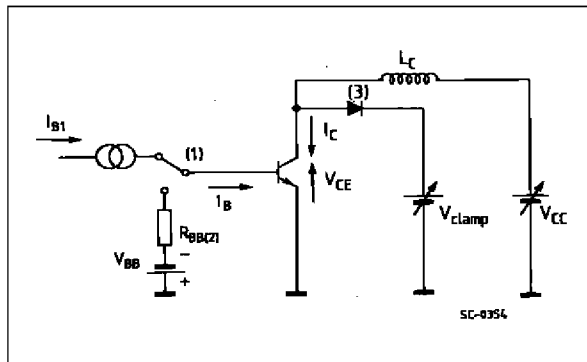

(1) Fast electronic switch (2) Non-inductive load (3) Fast recovery rectifier

Turn-off Switching Waveforms

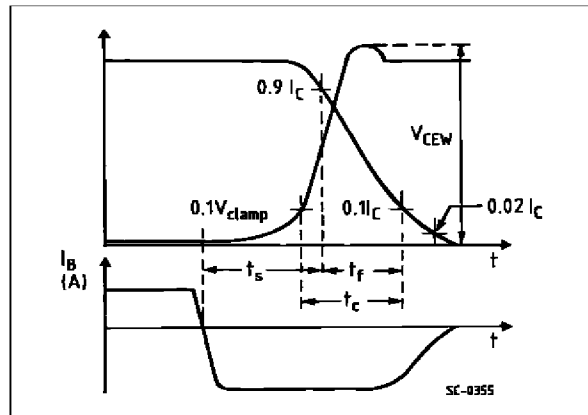

ISOTOP MECHANICAL DATA

DIM.	mm			inch		
	MIN.	TYP.	MAX.	MIN.	TYP.	MAX.
A	11.8		12.2	0.466		0.480
B	8.9		9.1	0.350		0.358
C	1.95		2.05	0.076		0.080
D	0.75		0.85	0.029		0.033
E	12.6		12.8	0.496		0.503
F	25.15		25.5	0.990		1.003
G	31.5		31.7	1.240		1.248
H	4			0.157		
J	4.1		4.3	0.161		0.169
K	14.9		15.1	0.586		0.594
L	30.1		30.3	1.185		1.193
M	37.8		38.2	1.488		1.503
N	4			0.157		
O	7.8		8.2	0.307		0.322

